





General Resistors / 通用电阻

- **Anti-Surge Resistors - RCR Series / 玻璃釉膜功率电阻器 ----- 1**
- **Carbon Resistors - CR Series / 碳膜电阻器 ----- 3**
- **CDS Resistors - PGM Series / 光敏电阻 ----- 4**
- **Cement Resistors - SQP, SQM, SQT, SQH, SQZ Series / 水泥电阻 ----- 9**
- **Composition Resistors (CCR) / 有机实芯电阻器 ----- 12**
- **Fusible Resistors - FRN, FKN, FSQ Series / 保险丝电阻 熔断电阻 ----- 14**
- **Metal Oxide Resistors - RSS, RSN Series / 氧化皮膜电阻器 ----- 16**
- **Precision Resistors Metal Film - MF Series / 精密金属膜电阻器 ----- 17**
- **Wirewound Resistors - KNP, KNPN Series / 绕线电阻器 ----- 19**
- **High Precision Axial Moulded Wirewound Resistors - BWW Series / 绕线电阻 ---- 21**
- **Vitreous Enamel Coated Wirewound Resistors - KNP-VE Series / 被釉绕线电阻 -- 23**
- **Zero Ohm and Jumper Wire Resistors - ZO, JW Series / 零欧姆、跳线电阻器 ----- 25**
- **Cement Resistor with Thermal Cut-offs - FKU/FRU Series / 温度保险丝电阻器 ---- 26**
- **Precision Power Wirewound Resistors - KNP-R Series / 精密功率绕线电阻器 --- 28**
- **Resistor Color Code / 电阻器色码系统 ----- 30**
- **Resistor Forming Type and Dimensions / 电阻加工类型与尺寸 ----- 32**
- **Resistor Glossary / 电阻器术语 ----- 34**
- **Resistor Precaution Usage / 各类型电阻使用注意事项 ----- 35**

Notice: Specification Changed or Version Updated will be posted at irregular intervals.
 All Updated and Final Specifications, Please Confirm with TOKEN ELECTRONICS REPRESENTATIVES.

 <http://www.token.com.tw>

 rfq@tokenonline.net

Taiwan: No. 137, Sec. 1, Chung Shin Rd., Wu Ku Hsiang, Taipei Hsien, Taiwan, R.O.C
 TEL: 886-2-2981 0109; FAX: 886-2-2988 7487

China: 12F, Zhongxing Industry Bld., Chuangye Rd., Nanshan District, Shenzhen, Guangdong
 TEL: 86-755-2605 5363, 2605 5364; FAX: 86-755-2605 5365



General Resistors

Anti-Surge Resistors - RCR Series

RCR Series are made by metal glaze coating on the surface of a cylindrical substrate with excellent characteristics and stable at even high resistance range.

Token offers competitive prices and are widely used in the power source protector like fluorescent's inverter, and starting resistor for Mercury Lamp. For high value resistance application, are widely used in computer and electronics, like protector of eliminate electrostatic and thunder lightning.

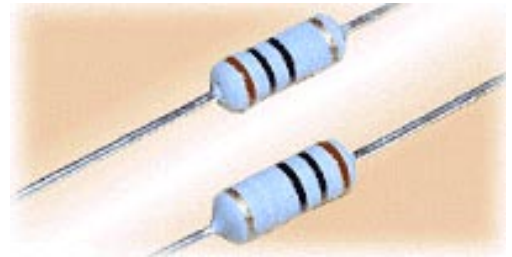

RCR Resistor General Specifications

Type	Power Rating	L	D	d ± 0.05	H
RCR25	1/4W	6.5±1	2.3±0.5	0.5 ~ 0.6	26±3
RCR50	1/2W	9.5±1	3.4±0.5		
RCR100	1W	12.0±1	4.0±0.5	0.7 ~ 0.8	
RCR200	2W	16.0±1	6.1±0.5		
RCR300	3W	17.0±1	7.0±0.5		
RCR500	5W	24.0±1	8.0±0.5		
RCR1000	10W	max.50	max.10		

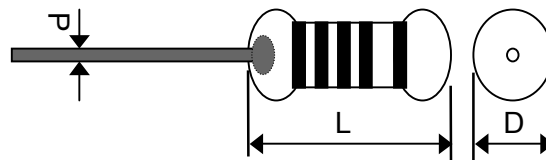

Anti-Surge Resistor RCR Power Rating

Type	Power Rating	Max Working Voltage	Max Overload Voltage	Dielectric With-standing Voltage	TCP. (ppm/°C)	Resistance Range E24. J(±5%)(Ω)	Operating Temp. range
RCR25	1/4W	500V	700V	500V	±350	1 ~ 33M	-20°C~+155°C
RCR50	1/2W	1000V	1500V	600V	±350	1 ~ 68M	
RCR100	1W	1500V	2500V	800V	±350	1 ~ 100M	
RCR200	2W	2000V	3000V	800V	±350	1 ~ 100M	
RCR300	3W	2500V	4000V	1000V	±350	1 ~ 100M	
RCR500	5W	3000V	5000V	1000V	±350	1 ~ 100M	

Anti-Surge Resistor Loading Conditions

Power	Resistance Range (Ω)	Surge Voltage	Anti-Surge Characteristics	Surge Test Condition
0.25 W	50K < R	3KV	(2.5 Sec. ON + 2.5 Sec. Off) × 10 Cycles ΔR ≤ ±(50%R+0.1Ω)	In accordance with IEC65 Safety specification.
0.5 W	10K ≤ R < 100K	3KV		
	100K ≤ R < 360K	5KV		
	360K ≤ R < 1M	7KV		
	1M ≤ R	10KV		

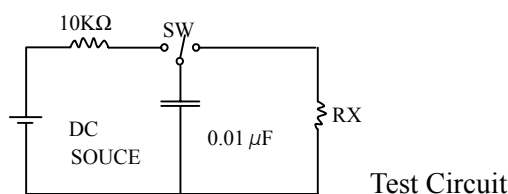



General Resistors

▶ How to Order

RCR50

❶

1/2W

❷

220KR

❸

J

❹

TB/P

❺

- ❶ Product type
- ❷ Rated Power (W)
- ❸ Resistance Value (Ω)
- ❹ Resistance Tolerance (%)
- ❺ Packaging





General Resistors

Carbon Resistors - CR Series

CR Series Carbon Resistor are the earliest and a still popular type made by breaking down hydrocarbon gases at high temperature in a vacuum to form a carbonic deposit on the surface of a cylindrical substrate. Trimming to value is accomplished by the cutting of spiral grooves. The material is painted on the substrate in a spiral pattern and cured at a moderately elevated temperature. Token offers competitive prices and widely used in the electronics, and consumer electrical industries.

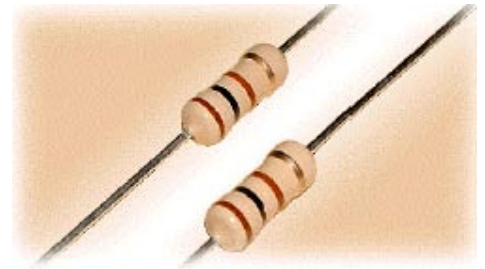

► Carbon Resistor General Specifications

Type RD	Power Rating		Dimension (mm)				Maximum Working Voltage	Maximum Overload Voltage	Resistance Tolerance	
	RD	RDS	L	D	H	d±0.05			± 2%(G)	± 5%(J)
CR-12	1/8 W	.	3.2±0.2	1.5±0.2	26±1	0.40~0.45	200	400	10Ω-470K	1Ω-4.7M
CR-16	1/6 W	1/4 W	3.2±0.2	1.5±0.2	26±1	0.40~0.45	200	400	1Ω-10M	0.5Ω-22M
CR-25	1/4 W	1/2 W	6.2±0.5	2.3±0.3	26±1	0.40~0.50	250	500	1Ω-10M	0.5Ω-22M
CR-33	1/3 W	1/2 W	8.5±0.5	2.8±0.3	26±1	0.50~0.55	250	500	1Ω-10M	0.5Ω-22M
CR-50	1/2 W	1 W	9.0±0.5	3.0±0.5	26±1	0.50~0.55	350	700	1Ω-10M	0.5Ω-22M
CR-100	1 W	2 W	11±1.0	4.0±0.5	35±3	0.75~0.80	500	1000	1Ω-10M	0.5Ω-22M
CR-200	2 W	3 W	15±1.0	5.0±0.5	35±3	0.75~0.80	500	1000	1Ω-10M	0.5Ω-22M
CR-300	3 W	5 W	17±1.0	6.0±0.5	35±3	0.75~0.80	500	1000	1Ω-10M	0.5Ω-22M

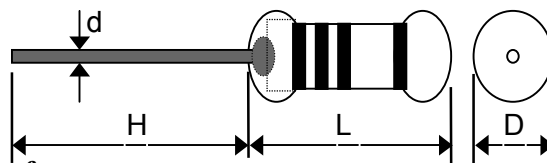

► Carbon Resistor Electrical Performance

Test Items	Condition	Spec
Short Time Over Load	2.5 Times of rated voltage for 5sec.	± 1%
Load Life	70 °C on-off cycle 1,000hrs.	± 5%
Moisture-Proof Load Life	40 °C 95% RH on-off cycle 1,000hrs	± 5%
Soldering After Resistance	350 °C for 3sec.	± 0.5%
Temperature Cycle	-30 °C~85 °C 5cycles	± 2%
Resistance Temperature Coefficient	1Ω~22KΩ 22KΩ~510KΩ 510KΩ~1MΩ 1MΩ~2.2MΩ 2.2MΩ~5.1MΩ	± 300PPM / °C ± 450PPM / °C ± 800PPM / °C ± 1000PPM / °C ± 1400PPM / °C

► How to Order

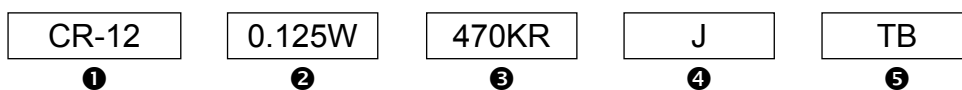

- ❶ Product type
- ❷ Rated Power (W)
- ❸ Resistance Value (Ω)
- ❹ Resistance Tolerance
- ❺ Packaging



General Resistors

CDS Resistors - PGM Series

CDS Photo Resistors - PGM series specification provides the mechanical data, electronic characteristics and test conditions in terms of 5mm, 12mm, and 20mm. Token CdS resistors can be customized designs and tighter tolerances available on request. Application of CdS resistors specific designs also available including different photo resistance and response time specifications adjusted to resistance requirements.

► CDS Resistor Features

1. Epoxy or hermetical package
2. Reliable Performance
3. Quick Response
4. Good Characteristic of Spectrum

► Applications

1. Auto Flash for Camera
2. Industrial Control
3. Photoelectric Control
4. Photoswitch; Electronic Toys

► 5mm CDS Photoresistors Configurations & Dimensions

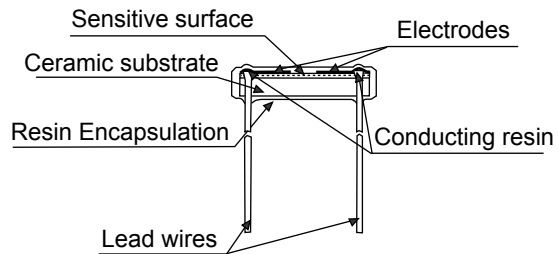

PGM5**** series
Epoxy resin package



PGM55**-MP series
Hermetical package

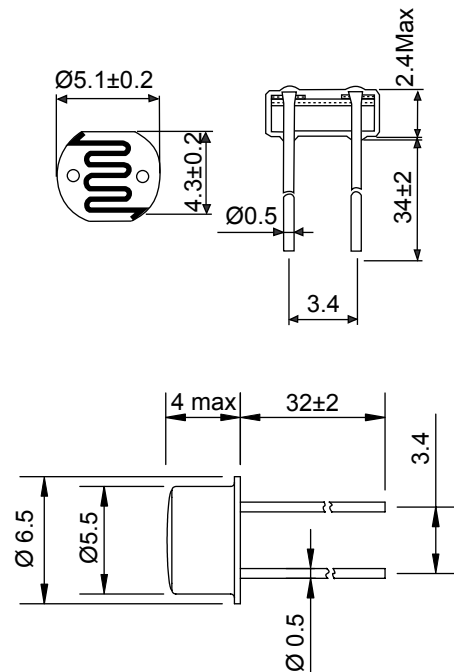

Note: All dimensions are in mm and NTS.

► CDS Resistors - PGM5**** series Electronics Characteristics

Model	Vmax (VDC)	Pmax (mW)	Ambient Temp (°C)	Spectral Peak (nm)	Photo Resistance (10Lx) (KΩ)	Dark Resistance (MΩ)min	γ min	ResponseTime (ms)	
								Rise	Decay
PGM5506	100	90	-30 ~ +70	540	2 ~ 6	0.15	0.6	30	40
PGM5516	100	90	-30 ~ +70	540	5 ~ 10	0.2	0.6	30	40
PGM5526	150	100	-30 ~ +70	540	8 ~ 20	1.0	0.6	20	30
PGM5537	150	100	-30 ~ +70	540	16 ~ 50	2.0	0.7	20	30
PGM5539	150	100	-30 ~ +70	540	30 ~ 90	5.0	0.8	20	30
PGM5549	150	100	-30 ~ +70	540	45 ~ 140	10.0	0.8	20	30
PGM5616D	150	100	-30 ~ +70	560	5 ~ 10	1.0	0.6	20	30
PGM5626D	150	100	-30 ~ +70	560	8 ~ 20	2.0	0.6	20	30
PGM5637D	150	100	-30 ~ +70	560	16 ~ 50	5.0	0.7	20	30
PGM5639D	150	100	-30 ~ +70	560	30 ~ 90	10.0	0.8	20	30
PGM5649D	150	100	-30 ~ +70	560	50 ~ 160	20.0	0.8	20	30
PGM5659D	150	100	-30 ~ +70	560	150 ~ 300	20.0	0.8	20	30



General Resistors

► CDS Resistors - PGM55**-MP series Electronics Characteristics

Model	Vmax (VDC)	Pmax (mW)	Ambient Temp (°C)	Spectral Peak (nm)	Photo Resistance (10Lx) (KΩ)	Dark Resistance (MΩ)min	γ _{min}	Response Time (ms)	
								Rise	Decay
PGM5506-MP	100	90	-30 ~ +70	540	2 ~ 6	0.15	0.6	30	40
PGM5516-MP	100	90	-30 ~ +70	540	5 ~ 10	0.2	0.6	30	40
PGM5526-MP	150	100	-30 ~ +70	540	8 ~ 20	1.0	0.6	20	30
PGM5537-MP	150	100	-30 ~ +70	540	16 ~ 50	2.0	0.7	20	30
PGM5539-MP	150	100	-30 ~ +70	540	30 ~ 90	5.0	0.8	20	30
PGM5549-MP	150	100	-30 ~ +70	540	45 ~ 140	10.0	0.8	20	30

► 12mm CDS Photoresistors Configurations & Dimensions

PGM12** series
Epoxy resin package

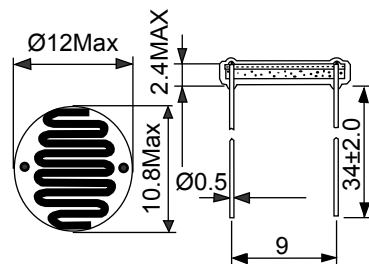

PGM12**-MP series
Hermetical package

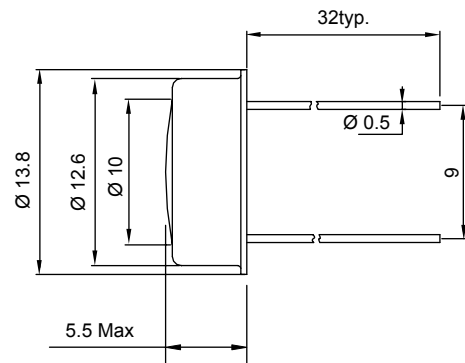

Note:All dimensions are in mm and NTS.

► CDS Resistors - PGM12** series Electronics Characteristics

Model	Vmax (VDC)	Pmax (mW)	Ambient Temp (°C)	Spectral Peak (nm)	Photo Resistance (10Lx) (KΩ)	Dark Resistance (MΩ)min	γ _{min}	Response Time (ms)	
								Rise	Decay
PGM1200	250	250	-30 ~ +70	560	2~5	1.0	0.6	30	40
PGM1201	250	250	-30 ~ +70	560	4~10	2.0	0.7	30	30
PGM1202	250	250	-30 ~ +70	560	8~20	5.0	0.7	30	30
PGM1203	250	250	-30 ~ +70	560	18~50	10	0.8	30	30
PGM1204	250	250	-30 ~ +70	560	45~150	20	0.8	30	30
PGM1205	250	250	-30 ~ +70	560	140~300	20	0.8	30	30





General Resistors

► CDS Resistors - PGM12**-MP series Electronics Characteristics

Model	Vmax (VDC)	Pmax (mW)	Ambient Temp (°C)	Spectral Peak (nm)	Photo Resistance (10Lx) (KΩ)	Dark Resistance (MΩ)min	γ_{min}	Response Time (ms)	
								Rise	Decay
PGM1200-MP	250	250	-30 ~ +70	560	2~5	1.0	0.6	30	40
PGM1201-MP	250	250	-30 ~ +70	560	4~10	2.0	0.7	30	30
PGM1202-MP	250	250	-30 ~ +70	560	8~20	5.0	0.7	30	30
PGM1203-MP	250	250	-30 ~ +70	560	18~50	10	0.8	30	30
PGM1204-MP	250	250	-30 ~ +70	560	45~150	20	0.8	30	30
PGM1205-MP	250	250	-30 ~ +70	560	140~300	20	0.8	30	30

► CDS Resistors - 20mm CDS Photoresistors Configurations & Dimensions



Note:All dimensions are in mm and NTS.

► CDS Resistors - PGM20** series Electronics Characteristics

Model	Vmax (VDC)	Pmax (mW)	Ambient Temp (°C)	Spectral Peak (nm)	Photo Resistance (10Lx) (KΩ)	Dark Resistance (MΩ)min	γ_{min}	ResponseTime (ms)	
								Rise	Decay
PGM2000	500	500	-30 ~ +70	560	2~5	1.0	0.6	30	40
PGM2001	500	500	-30 ~ +70	560	4~10	2.0	0.7	30	30
PGM2002	500	500	-30 ~ +70	560	8~20	5.0	0.7	30	30
PGM2003	500	500	-30 ~ +70	560	18~50	10	0.8	30	30
PGM2004	500	500	-30 ~ +70	560	45~150	20	0.8	30	30
PGM2005	500	500	-30 ~ +70	560	140~300	20	0.8	30	30



General Resistors

► CDS Resistors - PGM20**-MP series Electronics Characteristics

Model	Vmax (VDC)	Pmax (mW)	Ambient Temp (°C)	Spectral Peak (nm)	Photo Resistance (10Lx) (KΩ)	Dark Resistance (MΩ)min	γ min	Response Time (ms)	
								Rise	Decay
PGM2000-PP	500	500	-30 ~ +70	560	2~5	1.0	0.6	30	40
PGM2001-PP	500	500	-30 ~ +70	560	4~10	2.0	0.7	30	30
PGM2002-PP	500	500	-30 ~ +70	560	8~20	5.0	0.7	30	30
PGM2003-PP	500	500	-30 ~ +70	560	18~50	10	0.8	30	30
PGM2004-PP	500	500	-30 ~ +70	560	45~150	20	0.8	30	30
PGM2005-PP	500	500	-30 ~ +70	560	140~300	20	0.8	30	30

► CDS Resistors - Terminology

1. Light Resistance: Measured at 10 lux with standard light A (2854K-color temperature) and 2hr. preillumination at 400-600 lux prior testing.
2. Dark Resistance : Measured at 10th seconds after closing 10 lux.
3. Gamma characteristic:
Under 10 lux and 100 lux and given by
 $\gamma = \log(R_{10}/R_{100}) / \log(100/10) = \log(R_{10}/R_{100})$
R₁₀, R₁₀₀: resistance at 10 lux and 100 lux. The tolerance of γ is ±0.1.
4. Pmax: Max power dissipation at ambient temperature of 25°C. At higher ambient temperature, the maximum power permissible may be lowered.
5. Vmax: Max voltage in darkness that may be applied to the device continuously.
6. Spectral peak: Spectral sensitivity of photoresistors depends on the wavelength of light they are exposed to and in accordance with fig 2. The tolerance of spectral peak is ±50nm.

► CDS Resistors - Spectral Response

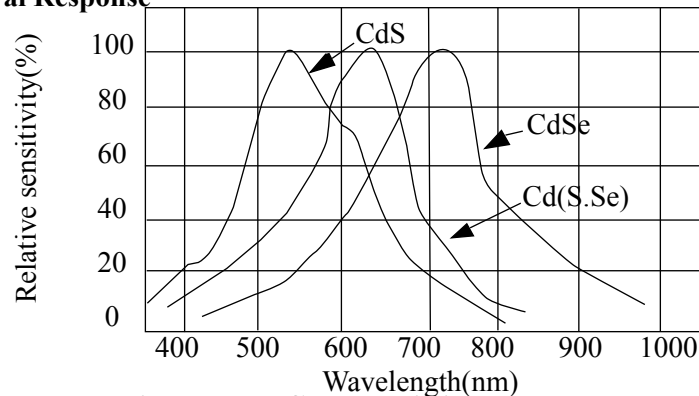

► CDS Resistors - Physical and Environmental Characteristics

ITEM	CONDITIONS	PERFORMANCE
Solderability	Put the terminals into welding tank at temp. 230±5°C for 2±0.5s (terminal roots are 5mm away from the tin surface).	wetting>95%
Temperature Changing	Change of temperature in accordance with: TA: -40°C TB: +60°C Number of cycles: 5 Exposure duration: 30min	Drift of R ₁₀ = ± 20% No visible damage
Constant humidity and heat	1. Put the device in test box at Temperature: 60±5° CHumidity: 90-95% Illumination: 0lux Duration: 100h 2. Take the device and measure after 24h at normal temperature and humidity.	Drift of R ₁₀ = ± 30% No visible damage
Constant load Temperature	At 25±5°C Illumination: 150lux at rated power Duration: 600h	No visible damage
Wire Terminals Strength	Bend the wire terminal at its root to 90 degree, and then bend it to a opposite direction.	No visible damage
Vibration	Frequency: 50Hz Swing: 1.5mm with Directions: parallel to ceramic substrate normal to ceramic substrate. Duration: 2h	No visible dam



General Resistors

▶ **How to Order**

PGM5516

❶

P

❷

❶ Part Number





General Resistors

Cement Resistors - SQP, SQM, SQT, SQH, SQZ Series

SQ Series Cement Resistors are made by winding resistance wires around non-alkaline ceramic core or metal oxide film rod, which is added with a layer of heat and humidity resistant and non-corrosive protective material. Token offers wide range including SQP, SQM, SQZ, and SQH.

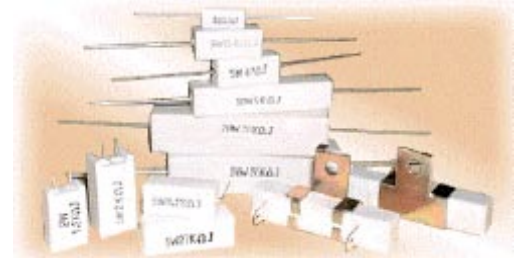

► Cement Resistor SQP Dimensions

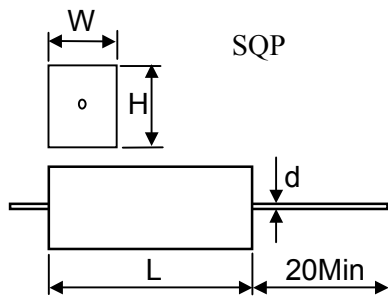

Type	Dimension (mm)				Resistance Range (Ω)	
	W \pm 1	H \pm 1	L \pm 1.5	d \pm 0.05	SQP	RS+SQP
2W	7	7	18	0.5~0.6	0.1~82	
3W	8	8	22	0.7~0.8	0.1~180	181~33K
5W	10	9	22	0.7~0.8	0.1~180	181~50K
7W	10	9	35	0.7~0.8	0.1~430	431~50K
10W	10	9	48	0.7~0.8	0.1~470	471~50K
15W	12.5	11.5	48	0.7~0.8	0.5~600	601~150K
20W-25W	14	13.5	60	0.7~0.8	0.8~1K	1.1~150K

► Cement Resistor SQM Dimensions

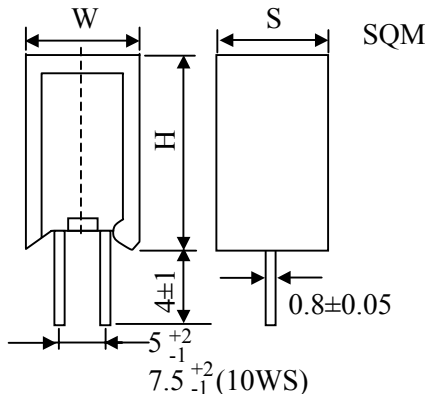

Type	Dimension (mm)			Resistance Range (Ω)	
	H \pm 1.5	W \pm 1	S \pm 1	SQM	RS+SQM
2W	20	12	8	0.1-8.0	81-50K
3W	25	12	8	0.1-180	181-50K
5W	25	13	9	0.1-180	181-50K
7W	39	13	9	0.1-430	431-47K
10W	51	13	12	0.1-470	471-47K
10WS	35	16	12	0.1-430	431-47K

► Cement Resistor SQT Dimensions

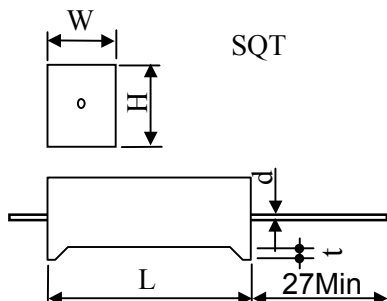

Type	Dimension (mm)				Resistance Range (Ω)	
	H \pm 1.5	W \pm 1	L \pm 1	t \pm 1	SQT	RS+SQM
3W	9	10	22	1.5	0.1-180	181-50K
5W	9	10	22	1.5	0.1-180	181-50K
7W	9	10	35	3.0	0.1-430	431-47K
10W	9	10	48	3.0	0.1-470	471-47K



General Resistors

► Cement Resistor SQH Dimensions

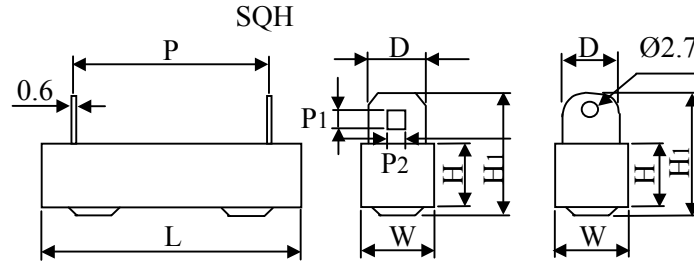

Type	Dimension (mm)								Resistance Range (Ω)		Max Working Voltage
	W±1	H±1	L±1.5	P±1	H1±1	D±0.5	P1±0.2	P2±0.2	SQH	RS+SQH	
10W	10	9	48	32	21	5	2.5	2	0.1~500	500~50K	500V
15W	12.5	11.5	48	32	21	5	2.5	2	1~1K	1K~150K	600V
20W	14.5	13.5	60	43	24	6	3.0	2.5	1~2K	2K~150K	700V
30W	19	19	75	56	29	6	3.0	2.5	1~2K		700V
40W	19	19	90	67	29	6	3.0	2.5	2~3K		700V
50W	19	19	90	67	29	6	3.0	2.5	2~3K		700V

► Cement Resistor SQZ Dimensions

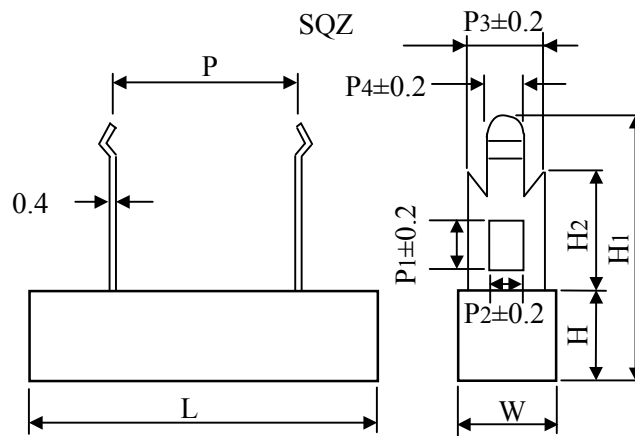

Type	Dimension (mm)										Resistance Range (Ω)	
	SQZ L±1.5	W±1	H±1	P±1.5	P1	P2	P3	P4	H1±1	H2±1	SQZ	RS+SQZ
5W	25(28)	10	10	9.5(15)	4.2	2	5	1.5	25	10.5	0.1-130	131-50K
7W	36	10	10	20	4.2	2	5	1.5	25	10.5	0.1-430	431-50K
10W	48	10	10	32	4.2	2	5	1.5	25	10.5	0.2-470	471-50K
15W	48	12.5	12	32	4.2	2	5	1.5	26	10.5	1-600	601-150K
20.25W	60	15	13	42	7	6	10	2.7	36	15.0	1-1K	1.1K-150K

► Cement Resistor Electrical Performance

TEST ITEMS	CONDITION	SPEC.
Resistance Temp Coeff.	-30°C~ 200°C	±300ppm / °C
Short Time Over Load	2.5 times of rated wattage for 5 sec.	±2 %
Rated Load	Rated wattage for 30 min.	±1 %
Voltage Withstanding	800 v AC 1 min.	no charge
Temp. Cycle	-30°C~ 85°C for 5 cycles	±1 %
Load Life	70°C on-off cycle 1000hrs.	±5 %
Moisture-proof Load Life	40°C 95% RH on-off cycle 500 hrs.	±5 %
Incombustibility	16 times of rated wattage for 5 min.	not flammed



General Resistors

► How to Order

SQP

❶

5W

❷

100 R

❸

J

❹

Bulk

❺

- ❶ Product type
- ❷ Rated Power
- ❸ Resistance Value (Ω)
- ❹ Resistance Tolerance
- ❺ Packaging





General Resistors

Composition Resistors (CCR)

Composition Resistor Features

1. Excellent characteristic against high voltage surge current .
2. Higher reliability for disconnection failure comparing to wirewound resistors and film resistors.

Applications

1. TV, CRT display, Copy machine .
2. LBP, VTR, Switch power supply, AV adapter .

Composition Resistor General Specifications

Type	Power Rating	L		Φ D	H	Φ d
CCR	1/4W	6.3	+1.0	2.3±0.3	27±3	0.60±0.05
			-1.5			
CCR	1/2W	10	+0.5	3.5±0.3	27±3	0.68±0.05
			-1.5			

Unit:mm

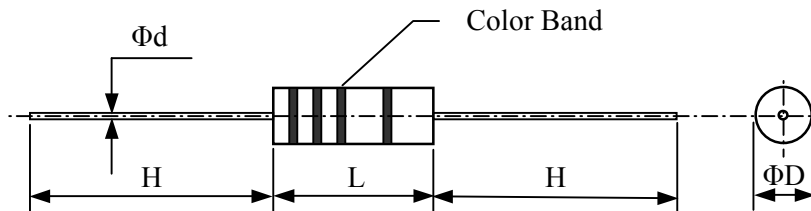

Composition Resistor Ratings

Type	Power Rating	Resistance Range	Tolerance E12,E24	Max Working voltage	Max overload Voltage	Rated Ambient Temp.	Operating Temp. Range
CCR	1/4W	2.2Ω ~12MΩ	J(±5%)K±10%	250V	350V	+70°C	-40°C~+125°C
CCR	1/2W	2.2Ω ~22MΩ		400V	700V	+70°C	-40°C~+125°C

Rated Voltage= $\sqrt{\text{Power Rating} \times \text{Resistance Value}}$ or Max. working voltage, whichever is lower.

Composition Resistor Derating Curve

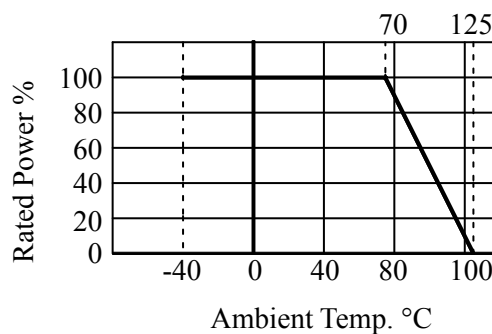



General Resistors

► Composition Resistor Performance

Description		Performance Requirements		Test Method
Resistance Temperature Coefficient	Resistance Range	Maximum Resistance Value Change %		Test Temperature +20°C /-40°C /+20°C /+100°C /+20°C
		-40~+20°C	+20~+100°C	
	<1KΩ	±6.5%	±5.0%	
	1.1KΩ ~10KΩ	±10%	±6.0%	
	11KΩ ~100KΩ	±13%	±7.5%	
	11KΩ ~1MΩ	±15%	±10%	
	1.1MΩ ~10MΩ	±20%	±15%	
	>11MΩ	±25%	±20%	
Short-time Overload		ΔR≤±2.5%		Rate Voltage*2.5 or maximum overload voltage (the lower)5sec.
With Standing Voltage		No flashover or breakdown		2times maximum working voltage 1 minute
Terminal Strength	Pulled	ΔR≤±2% No visible damage		Load 10N 10s
	Winded			Load 10N 4*90°
	Twisted			3*360° in opposite direction
Resistance to vibration		No visible damage		10~50Hz 3 direction 2 hours each
Solder-heat Resistance		ΔR≤±5% Marks legible,no visible damage		350°C 4mm from the body,3 seconds
Solderability		At least 95% if the dipping surface must be covered by new solder,no flaws gathered.		235°C 2mm from the body,2 seconds
Temperature Cycle		ΔR≤±2% No visible damage		-40°C(30min.)/85°C(30min.)5 cycles
Humidity		ΔR≤±10% No visible damage		40°C 95% RH 240 hours
Load Life		ΔR≤±10% No visible damage,marks legible		Rated voltage or maximum working voltage, 1.5 hours on, 0.5 hours off, 40°C 1000 hours

► How to Order

CCR	1/2W	120R	K	P
①	②	③	④	⑤

- ① Product Type
- ② Rated Power
- ③ Resistance Value(Ω)
- ④ Resistance Tolerance
- ⑤ Forming



General Resistors

Fusible Resistors - FRN, FKN, FSQ Series

Fusible Resistors - FRN, FKN, and FSQ Series are designed to act as an ordinary resistor under normal circuit conditions, and as a fuse under fault conditions. It is specially spiraled to provide the fusible function with flame retardant coating. Applications are widely used in constant voltage designed, overload protection, applicable for battery chargers, TV sets, cordless phones, and PC/CPU coolers. Token provides metal/carbon film (FRN), wirewound (FKN), and cement type (FSQ).



Fusible Resistor General Specifications

Type	Rated Wattage	Dimension (mm)						Resistance Range	Dielectric Withstanding Voltage
		L ± 1.5	D ± 1	H ± 0.5	W ± 0.5	H ± 3	d ± 0.05		
FRN	1/4W	6	2.3			26	0.40~0.50	0.22Ω~100KΩ	300V
	1/2W	6	2.3			26	0.50~0.55	0.22Ω~100KΩ	300V
	1W	9	3.0			26	0.50~0.55	0.22Ω~100KΩ	350V
	2W	11	4.0			26	0.75~0.80	0.3Ω~100KΩ	500V
	3W	15	5.0			35	0.75~0.80	0.3Ω~100KΩ	500V
FKN	1W	9	4.5			26	0.50~0.55	0.1Ω~22Ω	500V
	2W	11	5.0			26	0.75~0.80	0.1Ω~60Ω	500V
	3W	15	5.5			35	0.75~0.80	0.1Ω~100Ω	500V
	5W	17	6.5			35	0.75~0.80	0.2Ω~200Ω	500V
	6W	24	8.5			38	0.75~0.80	0.3Ω~250Ω	500V
FSQ	2W	18		7	7	35	0.50~0.55	0.1Ω~22Ω	1000V
	3W	22		8	8	35	0.75~0.80	0.1Ω~120Ω	1000V
	5W	22		9	10	35	0.75~0.80	0.2Ω~120Ω	1000V
	7W	35		9	10	35	0.75~0.80	0.3Ω~250Ω	1000V
	10W	48		9	10	35	0.75~0.80	0.3Ω~500Ω	1000V

FSQ dimensions refer to SQP cement type.

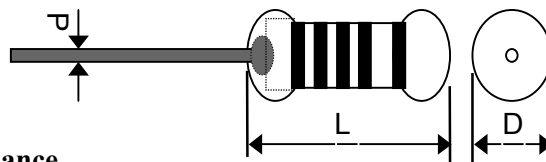

Fusible Resistor Electrical Performance

Test Items	Condition	Spec.
Operating Temp.	-30°C~155°C	
Resistance Temp. Coeff.	-30°C~150°C	± 200PPM / °C
Short Time Overload	2 times of rated voltage for 5 sec.	± 2 %
Temp. Cycle	-30°C~85°C for 5 cycles	± 1 %
Load Life	25°C on-off cycle 1,000 hrs.	± 5 %
Moisture-Proof Load Life	40°C 95°C RH on-off cycle 1,000 hrs.	± 5 %
Solder Pot	270°C for 3 sec.	± 1 %
Incombustibility	16 times of rated wattage for 5 min.	not flamed

Fusible Resistors - Fusing Characteristics

POWER WATTAGE	FUSING TIME
16 X Rated Wattage	Within 2 min
24 X Rated Wattage	Within 1 min
32 X Rated Wattage	Within 30 sec.



General Resistors

► How to Order

FRN

❶

1/2W

❷

0.47R

❸

J

❹

TB/P

❺

- ❶ Product type
- ❷ Rated Power (W)
- ❸ Resistance Value (Ω)
- ❹ Resistance Tolerance
- ❺ Packaging





General Resistors

Metal Oxide Resistors - RSS, RSN Series

Metal Oxide Resistor RSS and RSN Series have a resistance element formed by the oxidation reaction of a vapor or spray of tin chloride solution on the heated surface of a glass or ceramic rod. The resulting tin-oxide film is adjusted to value by cutting a helix path through the film. It can sustain high temperatures and electrical overloads, and supports moderate-to-precision attributes. Types include high power and flameproof axial through hole and surface-mounted devices.

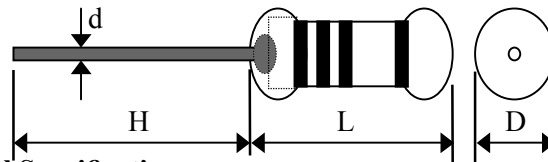
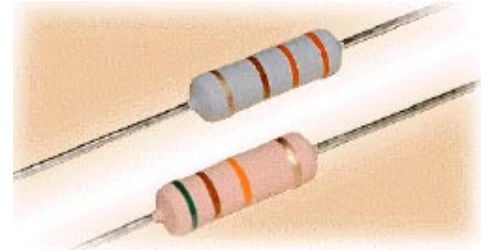

► Metal Oxide Resistor General Specifications

Type		L	D	H	d ± 0.05	MAX Working Voltage		Dielectric Withstanding Voltage	
RSS	RSN					RSS	RSN	RSS	RSN
1/2W	1/4W	6.0 ± 0.3	2.3 ± 0.3	26 ± 1	0.40~0.50	200V	300V	400V	500V
1W	1/2W	9.0 ± 0.5	3.0 ± 0.5	26 ± 1	0.50~0.55	250V	350V	500V	600V
2W	1W	11 ± 1.0	4.0 ± 0.5	26 ± 3	0.75~0.80	300V	350V	600V	700V
3W	2W	15 ± 1.0	5.0 ± 0.5	35 ± 3	0.75~0.80	350V	350V	700V	700V
5W	3W	17 ± 1.0	6.0 ± 0.5	35 ± 3	0.75~0.80	350V	500V	700V	1000V
6W	5W	24 ± 1.0	8.0 ± 0.5	38 ± 3	0.75~0.80	500V	700V	800V	1000V
7W	6W	24 ± 1.0	8.0 ± 0.5	38 ± 3	0.75~0.80	500V	700V	800V	1000V
10W	7W	41 ± 1.0	8.0 ± 0.5	38 ± 3	0.75~0.80	750V	850V	850V	1000V
	10W	53 ± 1.0	8.0 ± 0.5	38 ± 3	0.75~0.80	750V	850V	850V	1000V

► Metal Oxide Resistor Electrical Performance

Requirements	Characteristics	Test Method	
		JIS C 5202	MIL-R-22684B
Operating Temp.Range	-55°C~200°C		
Temp.Coefficient (ppm C)	± 300	5.2	4.6.11
Max. Resistance Changes	Short Time Overload	± (1%+0.05Ω)	5.2A
	Effect of Soldering	± (1%+0.05Ω)	6.4 350°C 2Sec
	Temp.Cycling	± (1%+0.05Ω)	7.4-55°C / 85°C
	Moisture Resistance	± 5%	7.9 1,000hr
	Load Life	± 5%	7.10 1,000hr
Dielectric Withstanding Voltage	± (0.5%+0.05Ω)	5.7A	4.6.7
Non-Combustibility	The resistor shall withstand Overload test in accordance with Article UL492.2 13 without producing a fire hazard.		
Resistance to Solvents	No damage on the appearance,co.or bands.		

► How to Order

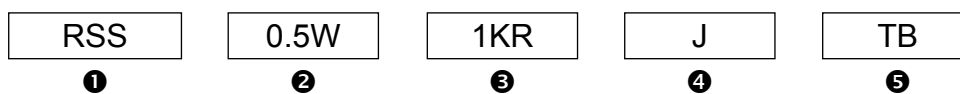

- ① Product type
- ② Rated Power
- ③ Resistance Value (Ω)
- ④ Resistance Tolerance
- ⑤ Packaging



General Resistors

Precision Resistors Metal Film - MF Series

MF Series Precision Resistor Metal Film use nickel-chromium or a similar alloy deposited on a ceramic rod by a vacuum process of evaporation or sputtering. The final resistance value is (most commonly) defined by cutting an insulating path through the film along the length of the rod while keeping it in rotation. The technology is capable of supporting accurate characteristics over a broad resistance range. Types include axial through-hole and metal film fusible for special purpose.

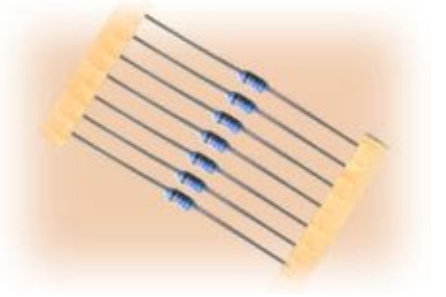

► Precision Resistor Metal Film General Specifications

STYLE	MIL STYLE	POWER RATING(W)		DIMENSION (mm)				MAX WORKING VOLTAGE		MAX OVERLOAD VOLTAGE	
		RN	RNS	L	D	H	d ± 0.05	RN	RNS	RN	RNS
MF - 12	RN-50	1/8W	1/4W	3.2 ± 0.2	1.5 ± 0.2	26 ± 1.0	0.40~0.45	200	150	400	300
MF - 25	RN-55	1/4W	1/2W	6.0 ± 0.3	2.3 ± 0.3	26 ± 1.0	0.40~0.50	250	200	500	400
MF - 50	RN-60	1/2W	1W	9.0 ± 0.5	3.0 ± 0.5	26 ± 1.0	0.50~0.55	350	250	700	500
MF - 100	RN-65	1W	2W	11 ± 1.0	4.0 ± 0.5	35 ± 3.0	0.75~0.80	500	300	1000	600
MF - 200	RN-70	2W	3W	15 ± 1.0	5.0 ± 0.5	35 ± 3.0	0.75~0.80	500	350	1000	700

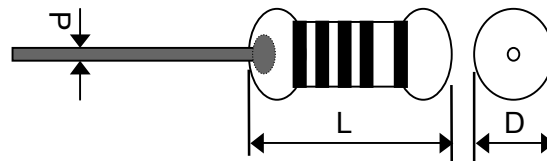

► Precision Resistor Metal Film Resistance Range

STYLE	MIL STYLE	TOLERANCE	TC+15-25PPM	TC+50PPM	TC+100PPM	REMARK
MF-12	RN-50	±1% ±0.5% ±0.25%	100Ω-100KΩ 100Ω-100KΩ 100Ω-100KΩ	10Ω-1MΩ	10Ω-1MΩ	*Standard resistance is 10Ω-1MΩ, below or over this resistance on request.
MF-25	RN-55	±1% ±0.5% ±0.25% ±0.1%	51.1Ω-511KΩ 51.1Ω-511KΩ 100Ω-300KΩ 100Ω-300KΩ	10Ω-1MΩ	10Ω-1MΩ	
MF-50	RN-60	±1% ±0.5% ±0.25% ±0.1%	51.1Ω-1KΩ 51.1Ω-1KΩ 100Ω-551KΩ 100Ω-330KΩ	10Ω-1MΩ	10Ω-1MΩ	
MF-100	RN-65	±1% ±0.5% ±0.25% ±0.1%	51.1Ω-1KΩ 51.1Ω-1KΩ 100Ω-551KΩ 100Ω-330KΩ	10Ω-1MΩ	10Ω-1MΩ	
MF-200	RN-70	±1% ±0.5% ±0.25% ±0.1%	51.1Ω-1KΩ 51.1Ω-1KΩ 100Ω-551KΩ 100Ω-330KΩ	10Ω-1MΩ	10Ω-1MΩ	





General Resistors

► Precision Resistor Metal Film Electrical Performance

REQUIREMENTS	CHARACTERISTICS	JIS C 5202	MIL-R-10509F
Operating Temp.Range	-55°C ~ 155°C		
Temp Coefficient (°C)	±25 ±50 ±100	5.2	4.6.12
Short Time Overload	±(0.5%+0.05Ω)	5.5 A	4.6.6
Dielectric Withstanding V	±(0.5%+0.05Ω)	5.7 A	4.6.8
Effect of Soldering	±(0.5%+0.05Ω)	6.4 350°C 3 sec	4.6.10
Temperature Cycling	±(0.5%+0.05Ω)	7.4	4.6.4
Low Temp Operation	±(0.5%+0.05Ω)		4.6.5
Terminal Strength	±(0.5%+0.05Ω)	6.1	4.6.7
Moisture Resistance	±(1%+0.05Ω)	7.9 1,000hr	MIL R-22684 4.6.10
Load Life	±(1%+0.05Ω)	7.10 1,000hr	4.6.13
Storage	±(0.2%+0.05Ω)	Shelved one year in a room of normal temperature and humidity	

► How to Order

MF-25

❶

1/4W

❷

100R

❸

J

❹

TB/P

❺

- ❶ Product type
- ❷ Rated Power
- ❸ Resistance Value (Ω)
- ❹ Resistance Tolerance
- ❺ Packaging



General Resistors

Wirewound Resistors - KNP, KNPN Series

Wirewound Resistor KNP and KNPN Series construction consists of a measured length of resistance wire (metal alloy) wound on a core (usually a ceramic). The element assembly is then protected by a coating or enclosure of insulating material (such as: vitreous enamel, silicone, cement, epoxy, etc.). KNP/KNPN is typically used where large power dissipation is required and where AC performance is relatively unimportant. Token provides KNP normal type, and KNPN non-inductive type.

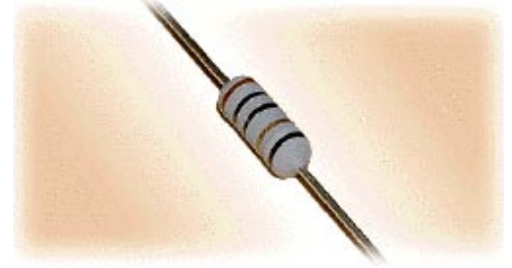

► Wirewound Resistor General Specifications

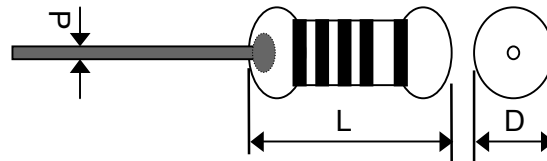

Type	Rated Watts	Dimensions (mm)				Resistance Range (Ω)	Tolerance
		$D \pm 0.5$	$L \pm 1$	$H \pm 3$	$d \pm 0.05$		
KNP	KNP-50	1/2W	4	9.0	26	0.50~0.55	$\pm 1\% \sim 5\%$
	KNP-100	1W	4	9.0	26	0.50~0.55	
	KNP-100B	1W	4.5	11.5	26	0.75~0.80	
	KNP-200	2W	4.5	11.5	26	0.75~0.80	
	KNP-200B	2W	5.5	15.5	35	0.75~0.80	
	KNP-300	3W	5.5	15.5	35	0.75~0.80	
	KNP-400	4W	6.5	17.5	35	0.75~0.80	
	KNP-500	5W	6.5	17.5	35	0.75~0.80	
	KNP-500B	5W	8.5	24.5	38	0.75~0.80	
	KNP-600	6W	8.5	24.5	38	0.75~0.80	
	KNP-700	7W	8.5	24.5	38	0.75~0.80	
	KNP-800	8W	8.5	42	38	0.75~0.80	
	KNP-1000	10W	8.5	42	38	0.75~0.80	
	KNP-1000B	10W	8.5	54	38	0.75~0.80	
KNP-1250	12.5W	8.5	54	38	0.75~0.80		
KNPN	KNPN-50	1/2W	4	9.0	26	0.50~0.55	$\pm 1\% \sim 5\%$
	KNPN-100	1W	4	9.0	26	0.50~0.55	
	KNPN-100B	1W	4.5	11.5	26	0.75~0.80	
	KNPN-200	2W	4.5	11.5	26	0.75~0.80	
	KNPN-200B	2W	5.5	15.5	35	0.75~0.80	
	KNPN-300	3W	5.5	15.5	35	0.75~0.80	
	KNPN-400	4W	6.5	17.5	35	0.75~0.80	
	KNPN-500	5W	6.5	17.5	35	0.75~0.80	
	KNPN-500B	5W	8.5	24.5	38	0.75~0.80	
KNPN-600	6W	8.5	24.5	38	0.75~0.80		



General Resistors

► Wirewound Resistor Electrical Performance

TEST ITEMS	CONDITION	SPEC
Resistance Temp. Coeff.	-55 °C ~ 155 °C	± 300 PPM / °C
Short Time Overload	10 times of rated wattage for 5 sec.	± 2 %
Rated Load	Rated wattage 30 min.	± 1 %
Voltage Withstanding	500VAC 1 min	± 1 %
Temperature Cycling	-20 °C ~ 85 °C 5 cycles	± 1 %
Load Life	70 °C on ~ off cycle 1000 hrs.	± 5 %
Moisture-Proof Load Life	40 °C 95% RH on ~ off cycle 500 hrs.	± 3 %
Incombustibility	16 times of rated wattage for 5 min	not flamed

► How to Order

KNP-100	1W	1R	J	TB/P
❶	❷	❸	❹	❺

- ❶ Product type
- ❷ Rated Power
- ❸ Resistance Value (Ω)
- ❹ Resistance Tolerance
- ❺ Packaging



General Resistors

High Precision Axial Moulded Wirewound Resistors - BWW Series

► Moulded Wirewound Resistors Features:

- Axial Moulded Type.
- High Precision.
- High Reliability.
- Excellent load life stability.
- Insulation, Moisture Proof.
- Meets the Standards of MIL-R-93.



► Moulded Wirewound Resistors Technical Specifications

Type	RateWatts at 25°C (W)	Resistance Range (Ω)		Tolerance (%)	TCR (PPM/°C)	Dimensions (mm)			
		Min	Max			A±0.25	ΦB±0.25	Φd	F
BWW-0.5	0.5	0.1	100	±0.1 ±0.25 ±0.5 ±1 ±2	±25 ±50 ±150	7.0	3.0	0.8	27.0
BWW-1	1.0	0.1	1K			11.0	3.0	0.8	31.0
BWW-3	3.0	0.1	10K			15.0	5.2	0.8	34.0
BWW-4	4.0	0.1	15K			18.0	6.5	0.8	38.0
BWW-5	5.0	1	24K			24.0	8.4	1.0	44.0
BWW-10	10.0	1	39K			46.5	10.0	1.0	66.0

Power Derating Curve

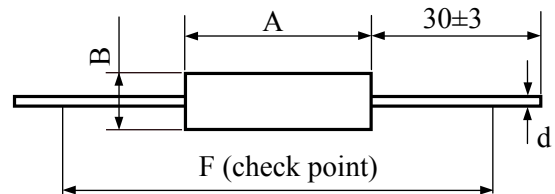
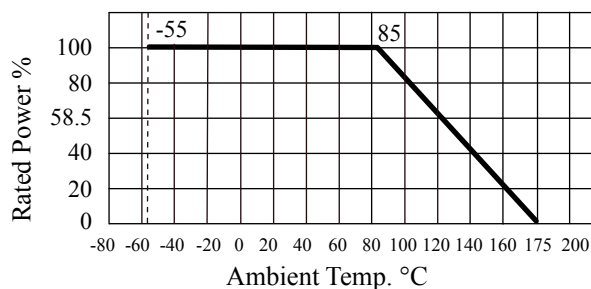

► Moulded Wirewound Resistors Performance

Test Items	Test Conditions	Specifications
Operating Temp. Range		-55°C ~ 175°C
Insulation Resistance	500V	>1GΩ
Dielectric Withstanding Voltage	500V AC 1 Min.	$\Delta R \leq \pm 0.1\%R$
Load Life	70°C on~off cycle 1000 Hrs.	$\Delta R \leq \pm 1\%R$
Moisture-Proof Load Life	40°C 95% RH on~off cycle 21 Hrs.	$\Delta R \leq \pm 0.2\%R$
Resistance to soldering heat	350°C, 3.5s	$\Delta R \leq \pm 0.1\%R$
Solderability	235±5°C, 5s(solder bath method)	IEC68-2-20(1968)



General Resistors

► How to Order



❶ Product Type

❷ Power Rating

❸ Resistance

Code	Resistance
R100	0.1Ω
100R	100Ω
1KR	1000Ω

❹ Resistance Tolerance

Code	Resistance Tolerance
B	±0.1%
C	±0.25%
D	±0.5%
F	±1%
G	±2%

❺ TCR

Code	TCR
C	±25PPM/°C
D	±50PPM/°C
K	±150PPM/°C

❻ Packaging: P (Bulk)





General Resistors

Vitreous Enamel Coated Wirewound Resistors - KNP-VE Series

Wirewound resistor construction consists of a measured length of resistance wire (metal alloy) wound on a core (usually a ceramic). The element assembly is then protected by a coating or enclosure of insulating material (such as: vitreous enamel, silicone, cement, epoxy, etc.). Wirewound Resistors are typically used where large power dissipation is required and where AC performance is relatively unimportant. Token provides wirewound resistors (KNP-VE).



► Wirewound Resistors Technical Specifications

Type	Rated Watts (W)	Resistance Range (Ω)	Limiting Voltage (V)	Tolerance	Temperature Coefficient (PPM/ $^{\circ}$ C)	Dimensions (mm) (Max)		
						L	Φ D	Φ d
KNP-VE-2.5	2.5	1 ~ 1K	100	±5% ±10%	±250 ±400	12.7	5.6	0.8
KNP-VE-3	3	1 ~ 1K	120			14.0	7.0	
KNP-VE-5	5	1 ~ 3.6K	160			23.0	7.0	
KNP-VE-6	6	1 ~ 6.8K	200			22.2	8.0	
KNP-VE-8	8	1 ~ 20K	400			33.9	8.0	
KNP-VE-9	9	1 ~ 27K	500			38.1	8.0	1.0
KNP-VE-12	12	1 ~ 39K	750			53.5	8.0	

Power Derating Curve

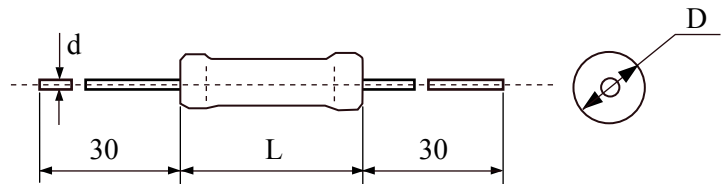
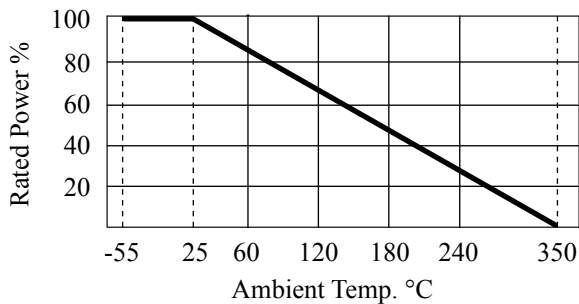

► Wirewound Resistors Performance

Test Items	Condition	Specifications
Insulation Resistance	500V	20M Ω
Short Time Overload	2.5 times of rated voltage 5 sec.	$\Delta R \leq \pm(2\%R + 0.05\Omega)$
Rated Load	Rated wattage 30 min.	$\Delta R \leq \pm(1\%R + 0.05\Omega)$
Dielectric Withstanding Voltage	500V AC 1 min	$\Delta R \leq \pm(1\%R + 0.05\Omega)$
Temp. Cycle	-20 $^{\circ}$ C ~ 85 $^{\circ}$ C 5 cycles	$\Delta R \leq \pm(1\%R + 0.05\Omega)$
Load Life	70 $^{\circ}$ C on ~ off cycle 1000 hrs.	$\Delta R \leq \pm(5\%R + 0.05\Omega)$
Moisture-Proof Load Life	40 $^{\circ}$ C 95% RH on~off cycle 500 hrs.	$\Delta R \leq \pm(3\%R + 0.05\Omega)$
Soldering After Resistance	350 $^{\circ}$ C for 3 sec	$\Delta R \leq \pm(0.5\%R + 0.05\Omega)$
Incombustibility	16 times of rated wattage for 5 min.	Not flamed



General Resistors

► How to Order

KNP-VE - 3W 100R J P

① ② ③ ④ ⑤

① Product Type

② Power Rating

③ Resistance

Code	Resistance
1R	1Ω
100R	100Ω
1KR	1000Ω

④ Resistance Tolerance

Code	Resistance Tolerance
J	±5%
K	±10%

⑤ Packaging

Code	Packaging
TB	Taping Box
P	Bulk



General Resistors

Zero Ohm and Jumper Wire Resistors - ZO, JW Series

ZO (Zero Ohm Resistor) and JW (Jumper Wire Resistor) Series are developed for the interconnection device Between points on a P.C. Board as jumper wires or Crossovers. Token offer a quick solution to the following problems, (1) Inability to connect two points on a P.C. Board due To other circuit paths which must be crossed over. (2) An After the fact design the requires new point connections. (3) Circuit tuning by changing point connections. Zero ohms are especially suited for automatic machine insertion.



► ZO (Zero Ohm Resistor) General Specification

ZO-TYPE

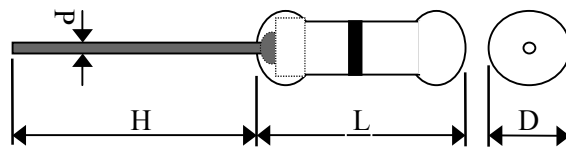

Type	Rating	Dimension (mm)			
		L Max.	D Max.	H ± 3	d+0.02-0.04
ZO - 1/8	0.125W	4.2	2.0	28	0.5
ZO- 1/4	0.25W	6.8	2.5	28	0.5

► JW (Jumper Wire Resistor) General Specification

JW-TYPE

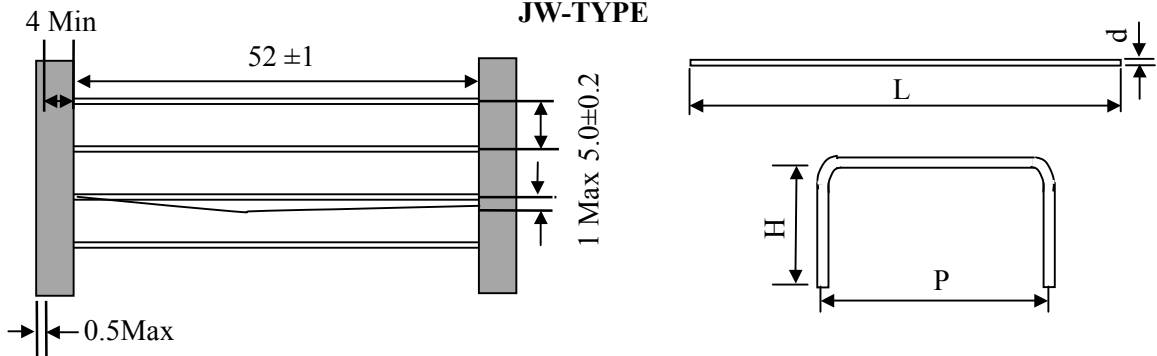

Type	L±1	d+0.02 -0.04	H	P
ZW-A	61.5	0.5	3 - 10	5 - 30
ZW-B	61.5	0.6	3 - 10	5 - 30

► Zero Ohm Resistor and Jumper Wire Resistor Electrical Performance

Requirements	Characteristics
Maximum Resistance	0.05sΩ
Lead Material	tin-plead copper
Body Material	Electrical grade, high performance molding compound
Dielectric Withstanding Voltage	Atomspheric-500V RMS, Reduced-325V RMS
Insulation Flammability	Resistor Insulation is self extinguishing within 10 seconds after externally applied flame is removed.
Current Rating	25 AMPS at 25°C, dreading to 0 AMPS at 150°C

► How to Order

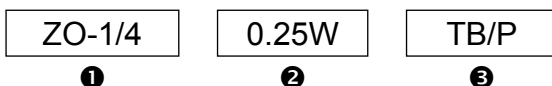

- ❶ Product type
- ❷ Rated Power (W)
- ❸ Packaging



General Resistors

Cement Resistor with Thermal Cut-offs - FKU/FRU Series

FKU, FRU Series Cement Resistor with Thermal Cut-offs include Metal Oxide type and Wirewound type, Cement Resistor with Thermal Cut-offs is specially sharp fusing characteristics, low cost and easy handling for one box type, space saving type, excellent anti-surge characteristics. Applications are widely used in Switching regulators, Video adapters or safety circuit in electrical equipment, etc..



► General Specifications

Type	Dimension (mm)						
	W ± 1	D ± 1	H ± 1.5	RM+2/-1	h	D1(R terminal)	D2(F terminal)
FKU/FRU-5M	13	9	25	5	4.5±1	0.8±0.1	2A:0.6±0.1 10A:1.0±0.1
FKU/FRU-7M	13	9	38	5			
FKU/FRU-10M	16	12	35	7.5			

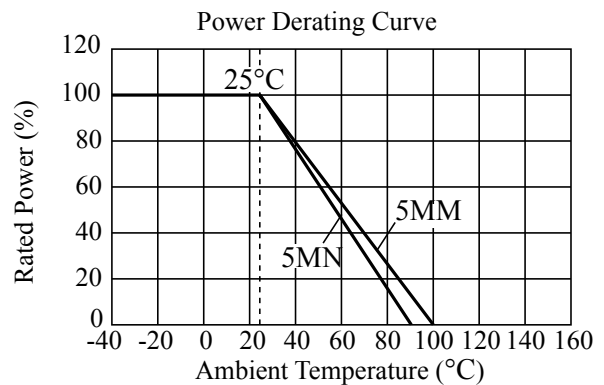
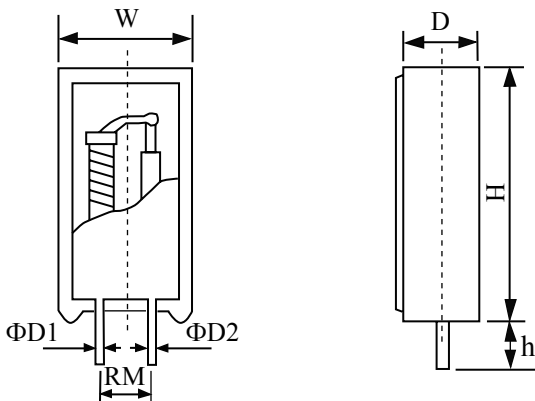

► Electrical Performance

Fusing Temperature Protector				Rated Power at 25°C (W)			Resistance Range(Ω)		Tolerance(%)	
MARK	Fusing Temperature(°C)	Standard Current(A)	Standard Voltage(V)	5M	7M	10M	FKU	FRU	FKU	FRU
A	109+1/-3	10	250	1.2	1.4	2.0	1~100	110~10K	J(±5) K(±10)	J(±5)
B	129±4			1.6	2.0	2.5				
C	152±4			1.6	2.0	2.5				
D	188+3/-1			2.0	2.4	3.5				
E	226+1/-3			2.0	2.4	3.5				
F	95+3/-0	2		0.8	1.2					
G	110±4			1.2	1.4					
H	126±4			1.4	1.6					
N	130±4			1.6	2.0					
M	145±4			2.1	2.4					



General Resistors

► How to Order



① Product type

Code	Product type
FRU	Metal Oxide type Thermal Cut-offs
FKU	Wirewound type Thermal Cut-offs

② Dimension Style: 5M, 7M, 10M

③ Thermal Cut-offs

Code	Dimension Style
A	109+1/-3°C
B	129±4°C
C	152±4°C
D	188+3/-1°C
E	226+1/-3°C
F	95+3/-0°C
G	110±4°C
H	126±4°C
N	130±4°C
M	145±4°C

④ Resistance Value

Code	Resistance Value
1R	1Ω
10R	10Ω
100R	100Ω
1KR	1000Ω

⑤ Resistance Tolerance

Code	Resistance Tolerance
J	±5%
K	±10%

⑤ Packaging: P (Bulk)



General Resistors

Precision Power Wirewound Resistors - KNP-R Series

Precision power wirewound resistors KNP-R series meeting MIL-R-26E (U and V characteristics) and surface temperature (hot spot) 375°C max. Resistors with a wide range of 0.01Ω ~ 82kΩ, covering applications from precision to power. Products with lead-free terminations meet EU RoHS and China RoHS requirements. Direct provides wirewound resistors (KNP-R).



Characteristics U:

275°C Maximum hot spot temperature. 1% Maximum ΔR in 1000 hours load life.

Characteristics V:

375°C Maximum hot spot temperature. 3% Maximum ΔR in 1000 hours load life.

Token KNP-R series have an operating temperature range of -55°C ~ +375°C, They must be derated at high ambient temperatures according to the chart below.

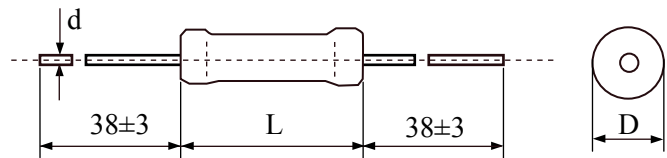
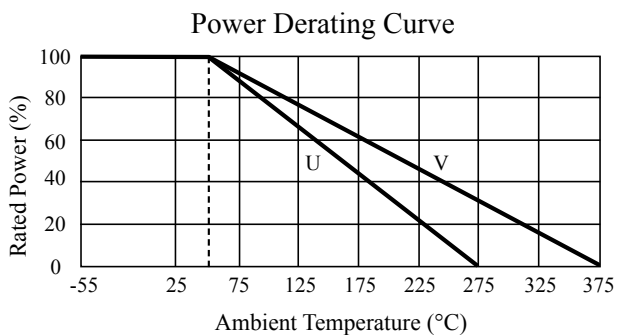

► Technical Specifications

Type	MIL - R-26E	Power Rating (W)		Max. Working Voltage (V)		Resistance Range (Ω)			Dimensions (mm)			
		U	V	U	V	0.1%	0.25%	0.5%	1%	3%	5%	L±0.81
KNP-R1/4	-	0.40	-	20	-	10~950	1~3.4K	6.35	1.98	0.51		
KNP-R1/2	RW70	0.75	-	29	-	10~1.3K	1~4.9K	7.92	1.98	0.51		
KNP-R1A	-	1.00	-	53	-	1~2.7K	0.1~10.4K	10.31	2.36	0.64		
KNP-R1	RW69	1.10	-	62	-	1~4.0K	0.1~15K	13.49	2.36	0.64		
KNP-R2A	-	2.50	3.25	138	157	1~8.6K	0.01~32.3K	12.70	5.33	0.81		
KNP-R2	RW79	3.00	3.75	135	148	1~5K	0.01~2K	13.49	4.06	0.81		
KNP-R3A	-	3.00	3.75	135	148	1~6.5K	0.01~34.5K	14.27	5.33	0.81		
KNP-R3	-	3.25	4.75	185	220	1~11.4K	0.01~42.1K	20.62	5.33	1.02		
KNP-R4	RW67	4.00	5.50	210	250	1~12.7K	0.01~47.1K	15.88	7.62	1.02		
KNP-R5	RW74	5.00	6.50	330	376	0.5~24.5K	0.01~51K	22.22	7.62	1.02		
KNP-R7	RW68	7.00	9.00	504	576	0.5~41.4K	0.01~75K	30.94	9.52	1.02		
KNP-R10	RW78	10.00	13.00	799	911	0.5~71.3K	0.01~82K	45.21	9.52	1.02		



General Resistors

► Electrical Performance - Wirewound Resistor

Test Items	Test Method	Specifications
Short Time Overload	2.5 times of rated voltage 5 sec.	$\Delta R \pm (2\% + 0.05\Omega)$
Rated Load	Rated wattage 30 minutes.	$\Delta R \pm (1\% + 0.05\Omega)$
Voltage Withstanding	500VAC 1 minute.	$\Delta R \pm (1\% + 0.05\Omega)$
Insulation Resistance	500V	20M Ω
Temp. Cycle	-20°C ~ 85°C 5 cycles	$\Delta R \pm (1\% + 0.05\Omega)$
Soldering After Resistance	235°C for 3 sec	$\Delta R \pm (0.5\% + 0.05\Omega)$
Incombustibility	16 times of rated wattage for 5 min.	Not flamed
Load Life	+25°C, 1.5Hrs on ~ 0.5Hrs off cycle, 1000 Hrs.	U: $\Delta R \pm (1\% + 0.05\Omega)$ V: $\Delta R \pm (3\% + 0.05\Omega)$

► How to Order

KNP-R3A

❶

U

❷

3R85

❸

B

❹

P

❺

❶ Product type

❷ Characteristic

Code	Characteristic
U	275°C
V	375°C

❸ Resistance

Code	Resistance
R100	0.1 Ω
1R	1 Ω
100R	100 Ω
1KR	1000 Ω

❹ Resistance Tolerance

Code	Resistance Tolerance
B	$\pm 0.1\%$
C	$\pm 0.25\%$
D	$\pm 0.5\%$
F	$\pm 1\%$
H	$\pm 3\%$
J	$\pm 5\%$

❺ Packaging

Code	Packaging
TB	Taping Box
P	Bulk



Resistor Color Code

Resistor Color Code

Token resistor color coding system applies to carbon film, metal oxide film, fusible, precision metal film, and wirewound (cylindrical with enlarged ends) of the axial lead type. This system is employed for resistors when the surface area is not sufficient to print the resistance value for the past time. At present, Token resistor color coding system is applying for automatization. The first three bands closest to one end of the resistor are used to determine the resistance. The fourth band represents the tolerance of the resistor. Additional information can be obtained from the first band. Generally, If an additional fifth band is black, the resistor is wirewound resistor. If an additional fifth band is white, the resistor is fusible resistor. If only one black band in the center, the resistor is called zero ohm resistor. The colors of the first two bands represent the numerical value of the resistor. The third band represents the power-of-10 multiplier.

► How to read the resistor code

First find the tolerance band, it will typically be gold (5%) and sometimes silver (10%). Starting from the other end, identify the first band - write down the number associated with that color; in this case Red is 2. Now 'read' the next color, here it is red so write down a 2 next to the two. (you should have '22' so far.) Now read the third or 'multiplier' band and write down that number of 1. In this example, the 'multiplier' band is Black so we get 22 Ω .

If the 'multiplier' band is Gold move the decimal point one to the left. If the 'multiplier' band is Silver move the decimal point two places to the left.

TOKEN RESISTOR COLOR CODE

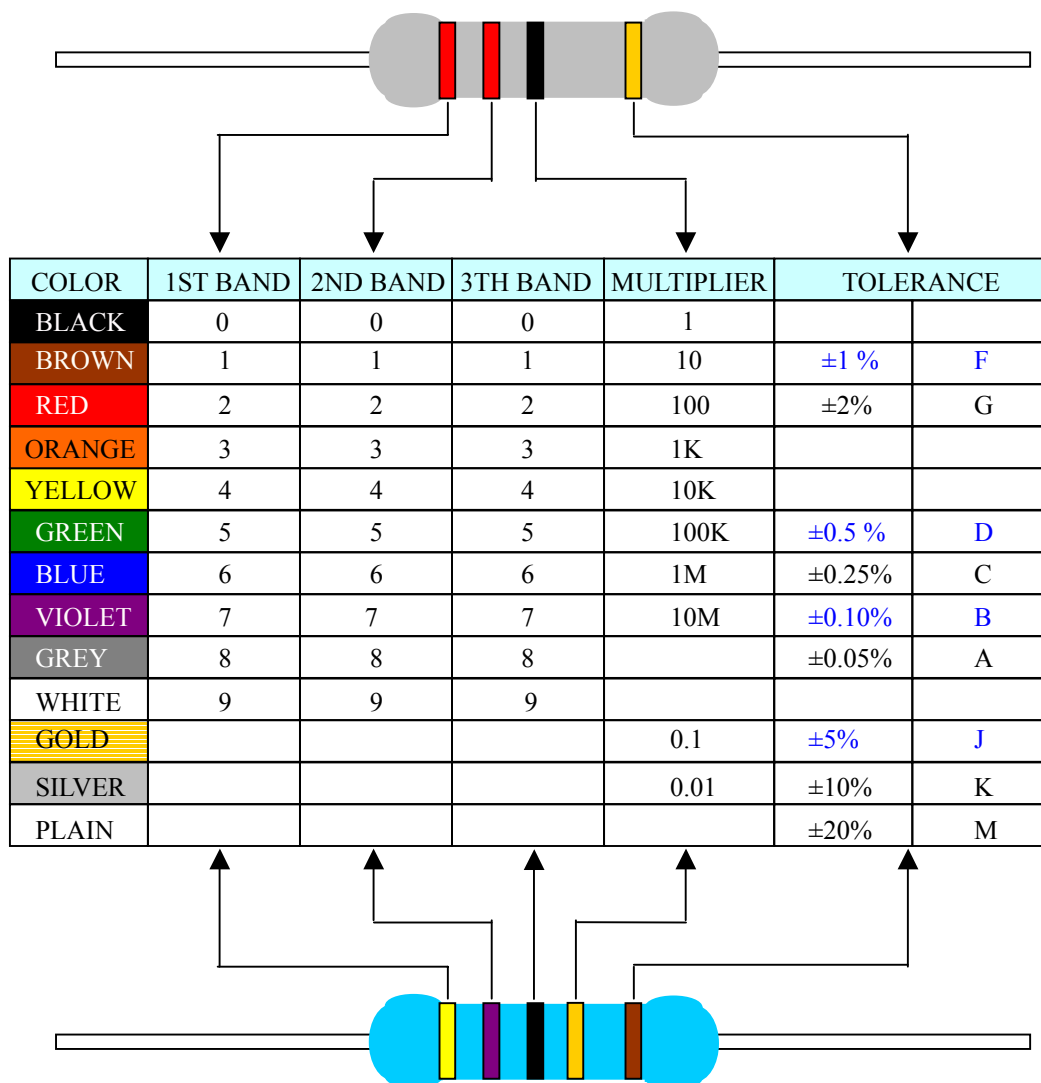



Resistor Color Code

► Resistance Tolerance

Symbol	A	B	C	D	F	G	J	K	M
Resistance tolerance	±0.05%	±0.1%	±0.25%	±0.5%	±1%	±2%	±5%	±10%	±20%

► Significant Figures of Nominal Resistance

E-6 RESISTANCE TOLERANCE (±20%)											
10	15	22	33	47	68

E-12 RESISTANCE TOLERANCE (±10%)											
10	12	15	18	22	27	33	39	47	56	68	82

E-24 RESISTANCE TOLERANCE (±2%; ±5%; ±10%)											
10	11	12	13	15	16	18	20	22	24	27	30
33	36	39	43	47	51	56	62	68	75	82	91

E-96 RESISTANCE TOLERANCE (±1%)											
10.0	10.2	10.5	10.7	11.0	11.3	11.5	11.8	12.1	12.4	12.7	13.0
13.3	13.7	14.0	14.3	14.7	15.0	15.4	15.8	16.2	16.5	16.9	17.4
17.8	18.2	18.7	19.1	19.6	20.0	20.5	21.0	21.5	22.1	22.6	23.2
23.7	24.3	24.9	25.5	26.1	26.7	27.4	28.0	28.7	29.4	30.1	30.9
31.6	32.4	33.2	34.0	34.8	35.7	36.5	37.4	38.3	39.2	40.2	41.2
42.2	43.2	44.2	45.3	46.4	47.5	48.7	49.9	51.1	52.3	53.6	54.9
56.2	57.6	59.0	60.4	61.9	63.4	64.9	66.5	68.1	69.8	71.5	73.2
75.0	76.8	78.7	80.6	82.5	84.5	86.6	88.7	90.9	93.1	95.3	97.6

E-192 RESISTANCE TOLERANCE (±0.1%; ±0.25%; ±0.5%)											
10.0	10.1	10.2	10.4	10.5	10.6	10.7	10.9	11.0	11.1	11.3	11.4
11.5	11.7	11.8	12.0	12.1	12.3	12.4	12.6	12.7	12.9	13.0	13.2
13.3	13.5	13.7	13.8	14.0	14.2	14.3	14.5	14.7	14.9	15.0	15.2
15.4	15.6	15.8	16.0	16.2	16.4	16.5	16.7	16.9	17.2	17.4	17.6
17.8	18.0	18.2	18.4	18.7	18.9	19.1	19.3	19.6	19.8	20.0	20.3
20.5	20.8	21.0	21.3	21.5	21.8	22.1	22.3	22.6	22.9	23.2	23.4
23.7	24.0	24.3	24.6	24.9	25.2	25.5	25.8	26.1	26.4	26.7	27.1
27.4	27.7	28.0	28.4	28.7	29.1	29.4	29.8	30.1	30.5	30.9	31.2
31.6	32.0	32.4	32.8	33.2	33.6	34.0	34.4	34.8	35.2	35.7	36.1
36.5	37.0	37.4	37.9	38.3	38.8	39.2	39.7	40.2	40.7	41.2	41.7
42.2	42.7	43.2	43.7	44.2	44.8	45.3	45.9	46.4	47.0	47.5	48.1
48.7	49.3	49.9	50.5	51.1	51.7	52.3	53.0	53.6	54.2	54.9	55.6
56.2	56.9	57.6	58.3	59.0	59.7	60.4	61.2	61.9	62.6	63.4	64.2
64.9	65.7	66.5	67.3	68.1	69.0	69.8	70.6	71.5	72.3	73.2	74.1
75.0	75.9	76.8	77.7	78.7	79.6	80.6	81.6	82.5	83.5	84.5	85.6
86.6	87.6	88.7	89.8	90.9	92.0	93.1	94.2	95.3	96.5	97.6	98.8



Resistor Forming Type and Dimensions

Resistor Forming Type and Dimensions

▶ Tape Type Dimensions

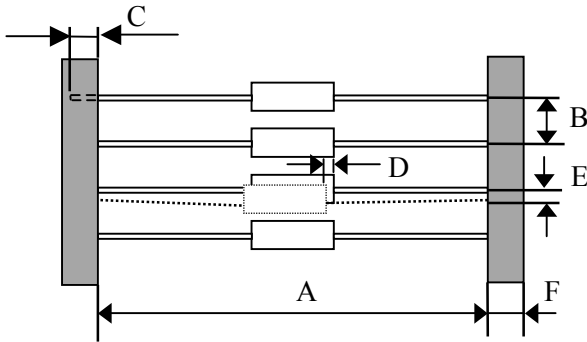

TYPE	T-26	T-52	T-63	T-73
A	26 ± 1	52 ± 1	63 ± 1.5	73 ± 1.5
B	5 ± 0.5	5 ± 0.5	10 ± 0.5	10 ± 0.5
C	5 ± 1	5 ± 1	5 ± 1	5 ± 1
D	Max 0.6	Max 0.6	Max 0.8	Max 0.8
E	Max 1.2	Max 1.2	Max 1.2	Max 1.2
F	6 ± 1	6 ± 1	6 ± 1	6 ± 1

▶ MB Form Dimensions

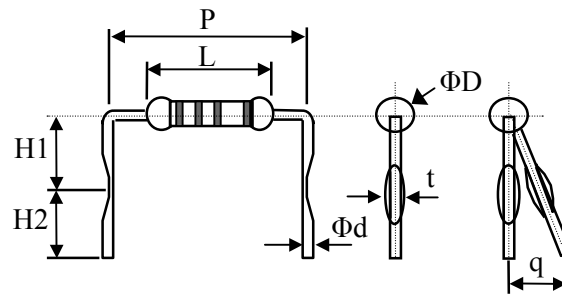

Watts		ΦD ± 0.5	L ± 1	P ± 1	H1 ± 1	H2 ± 0.5	d ± 0.5	t ± 0.2	q Max
1/2W	1WS	3	9	12.5	10.5	4	0.6	1.2	3
1W	2WS	4	11	15	10.5	4	0.8	1.25	3
2W	3WS	5	15	20	10.5	4	0.8	1.25	3
3W	5WS	6	17	25	10.5	4	0.8	1.25	3
5W	-	8	24	30	14	6.5	0.8	1.25	3

▶ F Form Dimensions

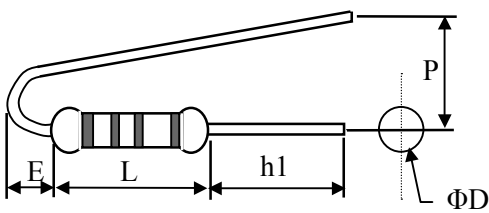

Watts		Dimensions				
		ΦD ± 0.5	L ± 1.0	P ± 2.0	E Max	h1 ± 1.0
1 / 2W	1WS	3	9	6	3.5	5
1W	2WS	4	11	6	3.5	5
2W	3WS	5	15	6	3.5	5
3W	5WS	6	17	6	3.5	5



Resistor Forming Type and Dimensions

► FK Form Dimensions

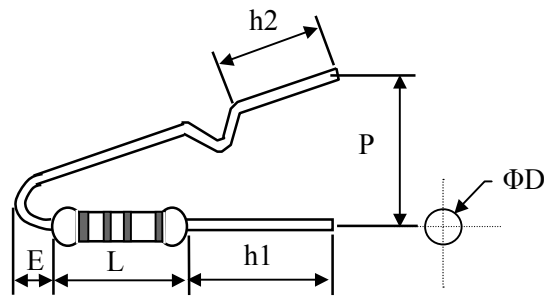

Watts		Dimensions					
		$\Phi D \pm 0.5$	$L \pm 1.0$	$P \pm 2.0$	E Max	$h1 \pm 1.0$	h2Max
1 / 2W	1WS	3	9	6	3.5	5	4
1W	2WS	4	11	6	3.5	5	4
2W	3WS	5	15	6	3.5	5	4
3W	5WS	6	17	6	3.5	5	4

► M Form Dimensions

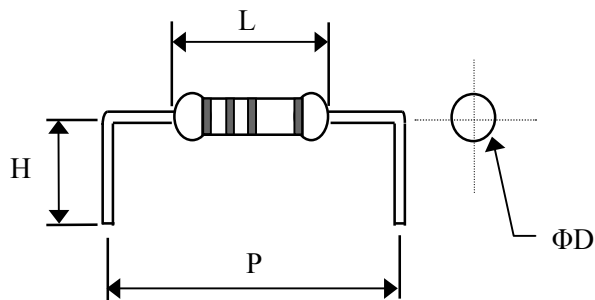

Watts		Dimensions			
		$\Phi D \pm 0.5$	$L \pm 1.0$	$P \pm 2.0$	$H \pm 1.0$
1 / 8W	1/4WS	1.5	3.2	6	10
1/4W	1/2WS	2.3	6	10	10
1/2W	1WS	3	9	12.5	10
1W	2WS	4	11	15	10
2W	3WS	5	15	20	10
3W	5WS	6	17	25	10
5W		8	24	30	20



Resistor Glossary

▶ **RATED POWER**

The maximum value of power, which can be continuously loaded to a resistor at a rated ambient temperature. Please confirm beforehand that there is such a case in a network that rated power per package as well as per element is specified.

▶ **RATED VOLTAGE**

The maximum value of D.C. voltage or A.C. voltage (commercial frequency effective value) capable of being applied continuously to resistors at the rated ambient temperature. Rated voltage shall be calculated from the following formula. However, it shall not exceed the maximum working voltage.

$$\text{Rated Voltage (V)} = \sqrt{\text{Rated Power (W)} \times \text{Nominal Resistance Value}(\Omega)}$$

▶ **CRITICAL RESISTANCE VALUE**

The maximum nominal resistance value at which the rated power can be loaded without exceeding the maximum working voltage. The rated voltage is equal to the maximum working voltage in the critical resistance value.

▶ **MAXIMUM WORKING VOLTAGE**

The maximum value of D.C. voltage or A.C. voltage (commercial frequency effective value) capable of being applied continuously to resistors or element. However, the maximum value of the applicable voltage is the rated voltage at the critical resistance value or lower.

▶ **MAXIMUM OVERLOAD VOLTAGE**

Specifications given herein may be changed at any time without prior notice. Please confirm technical specifications before you order and/or use. The maximum value of voltage capable of being applied to resistors for five seconds in the overload test. (JIS C 5201- 1 4.13) Typically the applied voltage in the short time overload test shall be 2.5 times larger than the rated voltage. However, it shall not exceed the maximum overload voltage.

▶ **DIELECTRIC WITHSTANDING VOLTAGE**

A.C. voltage (commercial frequency effective value) that can be applied to a designated spot between the electrode and the outer coating for a minute in the dielectric withstanding voltage test. (JIS C 5201- 1 4.7)

▶ **RATED AMBIENT TEMPERATURE**

The maximum ambient temperature at which resistors are capable of being used continuously with the prescribed rated load (power). The rated ambient temperature refers to the temperature around the resistors inside the equipment, not to the air- temperature outside the equipment.

▶ **DERATING CURVE**

The curve that expresses the relation between the ambient temperature and the maximum value of continuously loadable power at its temperature, which is generally expressed in percentage.

▶ **TEMPERATURE COEFFICIENT OF RESISTANCE(T.C.R.)**

The rate of change in resistance value per 1 °C in the prescribed temperature within the range of resistors operating temperature shall be expressed in the following formula:

$$\text{T.C.R. (ppm/°C)} = (\text{R}-\text{R}_0)/\text{R}_0 \times 1/(\text{T}-\text{T}_0) \times 10^6$$

R: Measured resistance(Ω) at T °C

R₀: Measured resistance(Ω) at T₀ °C

T: Measured test temperature(°C)

T₀: Measured test temperature(°C)





Resistor Precaution Usage

Resistor Precaution Usage

▶ Resistor Precautions in Usage

▶ Resistor in General

When an ambient temperature exceeds a rated ambient temperature, resistors shall be applied on the derating curve by derating the load power. General resistors are not combustion-resistant and are likely to emit, flame, gas, smoke, red heat, etc. under overloads. Flame retardant resistors generally emit smoke and red heat in a certain power and over but do not emit fire or flame.

When resistors are shielded or coated with resin etc., stress from the storage heat and the resin are applied to the resistors. So, performance and reliability of resistors should be checked well before use.

When a voltage higher than rated is applied in a short time (single pulse, repeated pulses, surge, etc.), it does not necessarily ensure safety that an effective wattage is not higher than a rated wattage. Then consult with us with your specified pulse wave shape. Resistors shall be used in a condition causing no dew condensation.

Keep temperature from rising by choosing resistors with a higher rated capacity; do not use a component having the exact load value required. For considerations of safety in extended period applications, the rating should be more than four times higher than the actual wattage involved, but never use resistors at less than 25% of its rated power.

In applications where resistors are subject to intermittent current surges and spikes, be sure in advance that the components selected are capable of withstanding brief durations of increased load.

Do not exceed the recommended rated load. Resistors must be used within the rated voltage range to prevent the shortening of service life and/or failure of the wound resistance elements.

Minimum load: Resistors must be utilized at 1/10 or more of the rated voltage to prevent poor conductance due to oxidation build-up. For basic particulars for cautions, refer to EIAJ Technical Report RCR- 2121 "Guidance for care note on fixed resistors".

▶ Metal Oxide Film Resistors

All resistors manufactured by Token Electronics Co., Ltd. comply with the U.S. UL-94 non-flammability test, Class V-0, a continuous combustion period of zero seconds.

Smoke emitted from non-flammable resistors on initial use in powered circuits is a normal phenomenon and the component can be safely utilized. Never use organic solvents to clean non-flammable resistors.

Non-flammable resistors cannot be utilized in oil. Non-flammable resistors cannot be used in high frequency machinery because of the inductance produced by the windings.

Although the hardness exceeds that of a 3H pencil lead, do not nick the coating with screwdrivers or other pointed objects.

Avoid touching non-flammable resistors in operation; the surface temperature ranges from approximately 350 °C to 400°C when utilized at the full rated value. Maintaining a surface temperature of 200°C or less will extend resistors service life.

Less resistant against external shocks than ordinary resistors due to special flame retardant coating. So, never give shocks or vibrations on the resistors. Also never damage them by picking up the coated films with pliers, tweezers, etc. After cleaning, no external power should be put on the coated films before they are well dried. A suitable type of resistors must be selected. Contact us for details.



Resistor Precaution Usage

▶ Wirewound Resistors

When being used in AC circuits, some wirewound structures give inductance ingredients or parasitic capacity, so they may cause unusual phenomena such as oscillations etc. Quorum deviations of other components should be carefully taken into account for use.

Application and Placement: Wire wound resistors use different gauges of wire as resistance elements. Sometimes the gauge is extremely thin (finer than a strand of human hair) and very susceptible to breakage in environments containing salts, ash, dust and corrosives. Avoid utilization in such environments.

Do not install in dusty areas because the accumulation will cause shorts and poor conductance.

▶ Fusing Resistors

When using, it shall be made sure that the overload conditions at unusual moments lie within the fusing territory. Consult with us in advance when overloaded higher than the rated voltage under an ordinary situation since such an overload may store up damages on resistors. Use at the maximum open- circuit voltage or lower as an arc phenomenon may arise when high voltage is applied again after fusing by an over current.

Consult with us for the maximum open- circuit voltage because it varies with type and resistance.

▶ Chip Networks

Care should be taken to the fact that slipping out of position during mounting may increase to cause solder bridges. As chip networks receive mechanical stress easier than chip resistors, take care so that no strong mechanical stress is given during and after the mounting. An incorrect solder volume increases stress on resistors and may result in cracks or performance defects. Be careful to avoid too much or too little soldered volume.

▶ Precautions in Use

The types and the specifications in this catalog are typical ones. Before use, please make sure of specifications and precautions in use with the contents of specifications for supply or ask our sales offices for the specifications.

▶ Particulars Common to all Kinds of Product Types

▶ Applications

When components are used for special applications requiring high reliability (life maintenance equipment, atomic energy, airplanes, artificial satellites, etc.), contact us beforehand. Also make sure to evaluate and verify the components in a state that they are mounted on actual equipment.

▶ Soldering

Soldering shall be performed within the specified temperature, time and number of times for each component. If the components are heated to high temperature for a long time, the colors and characteristics may change, and disconnection may occur.

After soldering, keep the component from stress until it is cooled down.

After soldering, be sure not to give any mechanical stress on the terminal section by warping of the printed board, etc.

▶ Insertion and Mounting

The coating is covered to ensure the performance of components. Do not give any damages or excessive impacts on the products with pliers or pinsetter, or improper adjustment of an automatic mounter. They may cause characteristic changes, disconnection, crack, etc.

Do not use the components dropped at the time of mounting or ones removed from the printed boards.

Make sure to avoid heat radiation generated by other heated components.

In case boards are sealed by molding or coated after mounting components, consult us beforehand.

Take care not to have electrostatics applied to the components when assembling.





Resistor Precaution Usage

▶ Resistance to Pulse

If the components are used in circuits where pulse wave current (single pulse, repeated pulse) or surge current flows, consult us beforehand. Also note that it is necessary to check with actual circuits considering dispersion of the tolerance values of the other components.

▶ Storage

The components should be kept away from high temperature, high humidity, direct sunlight, heat, corrosive gas (brimstone, chlorine, acid, alkali, etc.). Please inquire us about the storage term of products.

▶ Cleaning

Be careful not to leave ionic substances contained in solder flux after washing the flux. Especially when non-washing- soldering, water washing or water- soluble detergent is used, it is essential to confirm reliability of the components before use.

▶ General

For basic particulars for cautions, refer to EIAJ Technical Report RCR-1001 “Safety application guide for electronic parts “.

▶ Particulars Common to Chip Components

Warping of printed boards, which is caused by heat, gives stress directly to components when boards are cooled down. Be careful of the following particulars:

The arrangement of electrodes of chip components should go along with the fiber direction (vertical direction) of printed boards.

When printed boards are divided after soldering, proper positioning of the components is required in order to avoid any stress caused by warping, bending, etc. of the boards.

Be sure to design the same size of pads both on left and right sides.

If far different sizes of components are mixed on a board, take care of the positioning of the components.

▶ Particulars Common to Discrete Components

To avoid mechanical force to components, pay attention to following the particulars:

Be careful not to create resonance by vibration.

The bodies of the discrete components should be free from twisting or bending.

The bodies of the large components should be firmly fixed.

When the lead wires need to be bent, try to make larger radius of curve in order to avoid excessive force at the foot of the terminals.

When cutting or clinching the lead wires on the mounter, be careful not to apply excessive forces to them.

